

ELR Leo Flex tuneWHITE™ & WARM DIM recommended Driver Solution

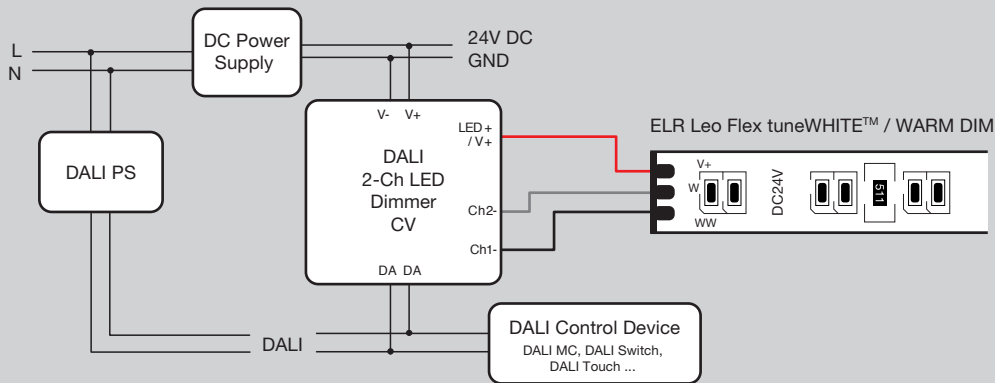

Wiring diagram of ELR Leo Flex tuneWHITE™ or WARM DIM with Lunatone DALI 2-Ch LED Dimmer CV

Operating Mode: DT8, Balance & Dim, Dim2Warm, SwitchDim2

DALI CW-WW LED Dimmer CV

Datasheet

Control Gear

DALI LED Dimmer (CV, DT8) for
the control of tunable white
luminaires (CW-WW)



Art. Nr. 89453836 (4A)

Art. Nr. 86458673 (8A)

Art. Nr. 89453838 (10A)

Art. Nr. 89453841 (16A)

DALI CW-WW LED-Dimmer CV Control Gear

Overview

- DALI LED-Dimmer for the control of tunable white luminaires
- suitable for constant voltage LED-modules with operating voltages from 12V to 48V
- **Operating Mode DT8:** one DALI-address for the independent control of light level and colour temperature (DALI DT8, Colour Type Tc)
- **Operating Mode Balance&Dim:** control by 2 DALI-addresses, one for adjusting the light level and one for adjusting the channel balance (e.g. colour temperature)
- **Operating Mode Dim2Warm:** one DALI-address for simultaneous adjustment of light level and colour temperature
- **SwitchDim2:** 2 switch-inputs offer control of level and colour without DALI
- dimming range 0.1%-100%
- adjustable PWM-frequency (122Hz/244Hz/488Hz/976Hz)
- compact types for integration in luminaires or remote ceiling
- supply voltage type dependent of 12V to 28V DC or from 12V to 48V DC (according to the operating voltage of the led modules)
- type dependent max. input currents of 4A, 8A, 10A or 16A
- the maximum input current can be distributed on the channels at will
- low standby power consumption
- high efficiency
- configuration via PC-software DALI-Cockpit and DALI USB-interface
- user-friendly factory default settings

Specification, Characteristics

type	DALI CW-WW Led Dimmer CV			
article number	89453836	86458673	89453838	89453841
electrical data:				
supply voltage Vin	12VDC-28VDC	12VDC-48VDC		
maximum input current Iinmax	4A	8A	10A	16A
control input	DALI	DALI SwitchDim2		
current consumption DALI	2mA			
number of DALI-addresses	operating mode DT8, Dim2Warm: 1 operating mode Balance&Dim: 2			
standby power consumption (12V)	120 mW			

type	DALI CW-WW Led Dimmer CV			
article number	89453836	86458673	89453838	89453841
technical data:				
power on behaviour	configurable via DALI: 0%-100% or last value			
ambient temperature	-20°C bis +60°C			
expected lifetime (at Tc<=75°C)	>100000h			
protection class	IP20			
max. connecting wire cross section	1.5 mm ²		2.5 mm ² / DALI & SwDim: 1.5 mm ²	
dimensions (LxWxH)	40mm x 28mm x 15mm	59mm x 33mm x 15mm	120mmx30mmx22mm	
housing/mounting	back box		remote ceiling	

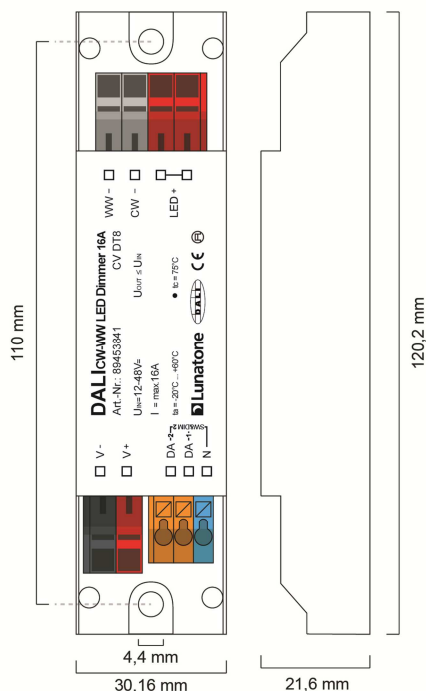

dimensions remote ceiling

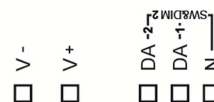
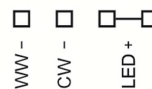

connection plan remote ceiling

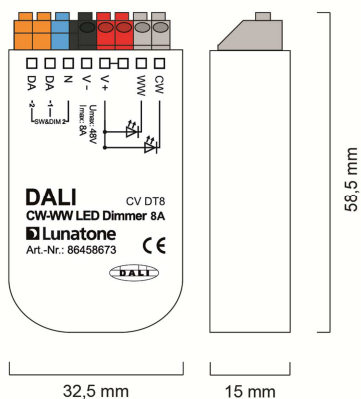

dimensions back box 8A

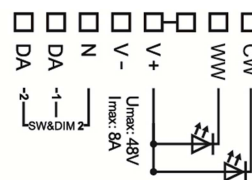

connection plan back box 8A

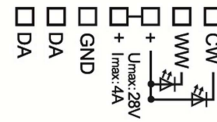
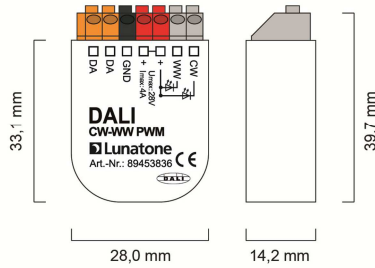

connection plan back box 4A

dimensions back box 4A

RECOMMENDATION: Care should be taken on keeping cable lengths between DC power supply and dimmer as well as between dimmer and luminaires (Led-Strings) as short as possible. This kind of installation will minimize the influence of voltage drops.

DALI:

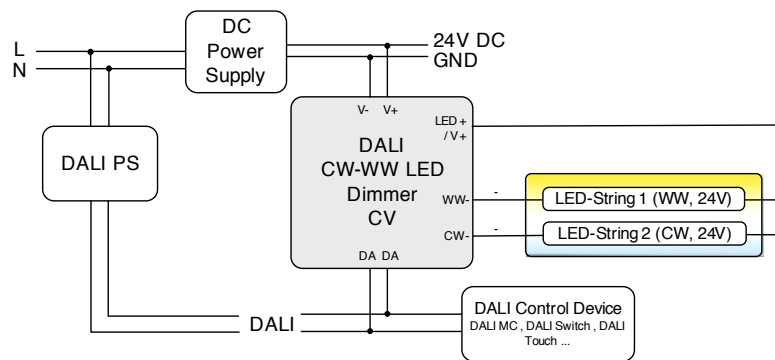

SwitchDim2:

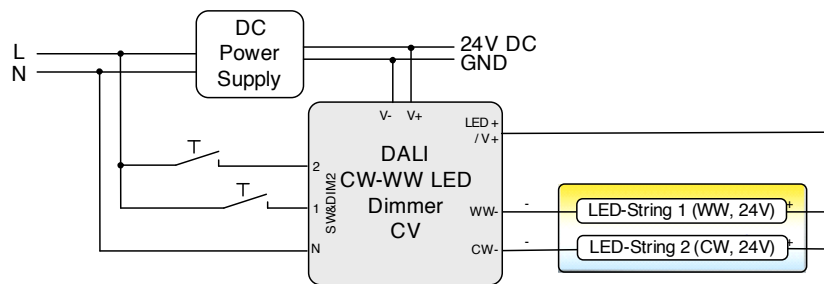

Operating Modes

The device offers several operating modes:

DT8 (factory default)

Default when connected to DALI in this operating mode one DALI-address for the independent control of light level and colour temperature is used (Device Type 8 Mode Tc).

Alternatively the device can be controlled using 2 switch-inputs for mains voltage (SwitchDim2):

SwD1: light level

short press: On/Off

long press: dimming

SwD2: colour temperature

long press: change colour temperature

Balance&Dim

This operating mode is also suitable for operating tunable white luminaires using two DALI-addresses. The first controls the light level and the second is used for changing the distribution on the output channels (e.g. for tunable white applications or balancing direct/indirect lighting).

The Balance&Dim mode allows colour temperature adjustments without affecting the light level and vice versa. For each channel only DALI-standard commands like dim up/down but also DAP are used. Thus the device can be used with all common controls and gateways (e.g. KNX). The Balance&Dim mode provides an alternative to the DT8-Tc mode.

Can be operated via DALI or SwitchDim2:

DALI-address 1, SwD1: light level

DALI-address 2, SwD2: balance

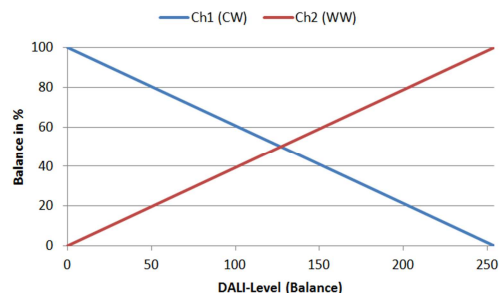

Dim2Warm

Both output channels are controlled by one DALI-address or SwD-input. The balance is coupled directly to the DALI dim level – the smaller the dim level the warmer the light.

DALI-address 1, SwD1: Dim2Warm (Master)

short press: On/Off

long press: dimming

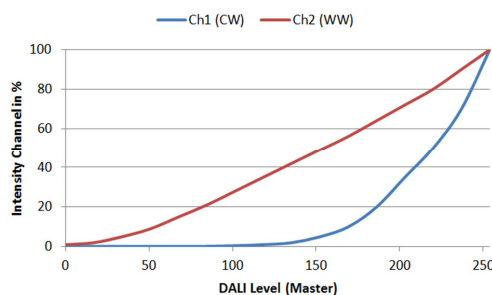

SwD2: scene selector

Selection of operating mode

With the help of the PC-software tool DALI-Cockpit the operating mode can be easily set on the general settings page.

Operating mode DT8-Tc:

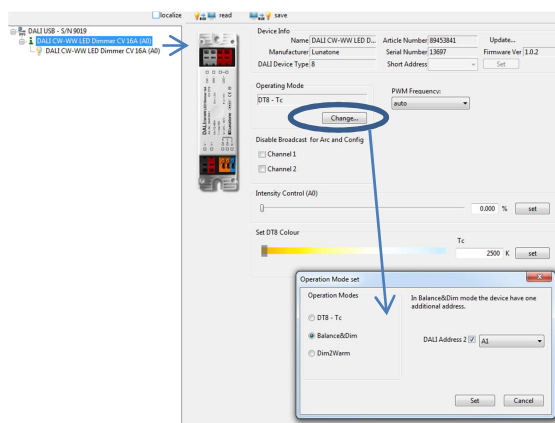

In addition, on the same page the PWM-frequency can be selected and basic control elements for testing each operating modes are available (DT8: slider for level and colour temperature, Balance&Dim: slider for level and balance, Dim2Warm: slider for input value adaption and Edit-Function for the Dim2Warm-table). Furthermore the broadcast control can be deactivated for each channel individually.

Operating Mode Balance&Dim:

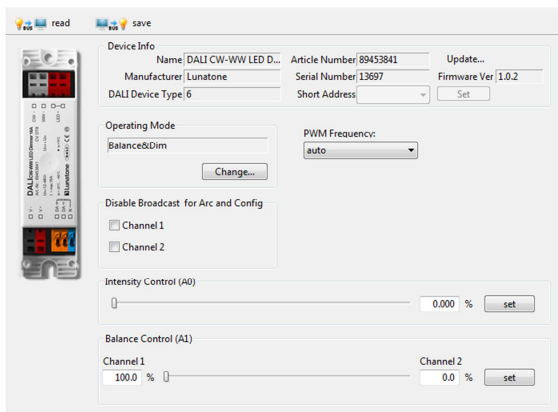

Operating Mode Dim2Warm:

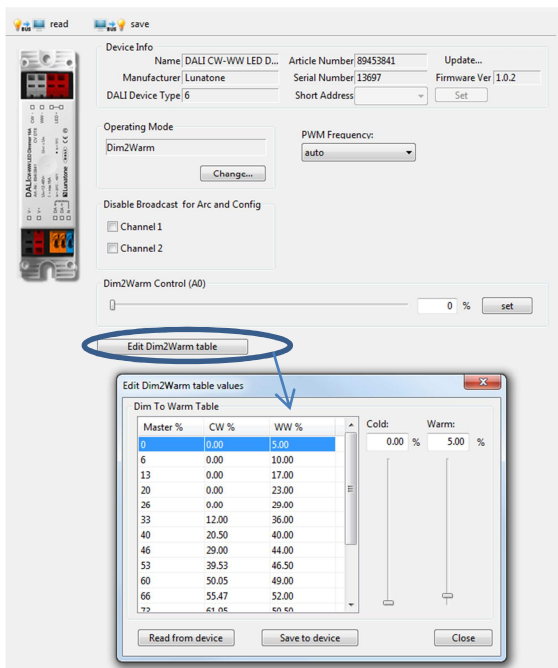

Switching between operating modes can also be done with the help of the DALI-command SET OPERATING MODE (IEC 62386-102 Ed.2). When changing the operating mode the

number of used DALI-addresses can change as well and this requires a new addressing procedure. In the DALI-Cockpit this address assignment is performed automatically.

Operating Mode:

Number	Operating Mode
0x0	DT8 (factory default)
0x92	DT8
0x94	Balance&Dim
0x95	Dim2Warm

Additional Settings

Besides the settings on the general page each channel can be selected separately in the component tree for individual configuration.

Component Tree:



Settings in the operating mode DT8-Tc (displayed parameters are the factory default values):

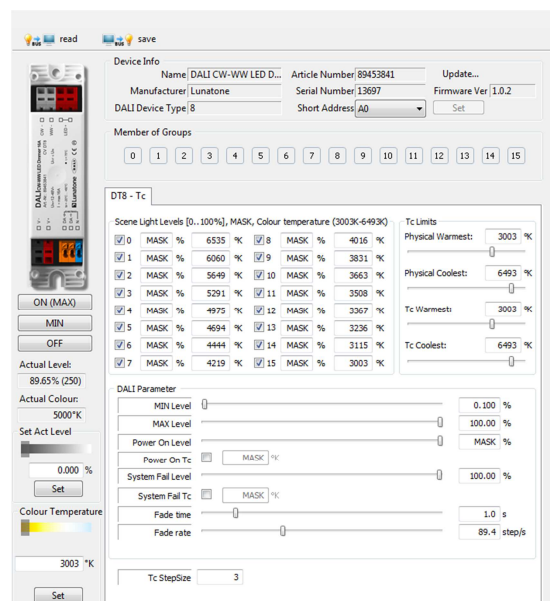

Beside the DT8 Tc standard settings, the Tc stepsize can be increased, this is a simple way to speed up colour temperature changes when using the commands TC STEP COOLER/WARMER.

In all other operating modes (Balance&Dim /Dim2Warm) the following settings are provided.

Operating mode Balance&Dim; Dim2Warm:

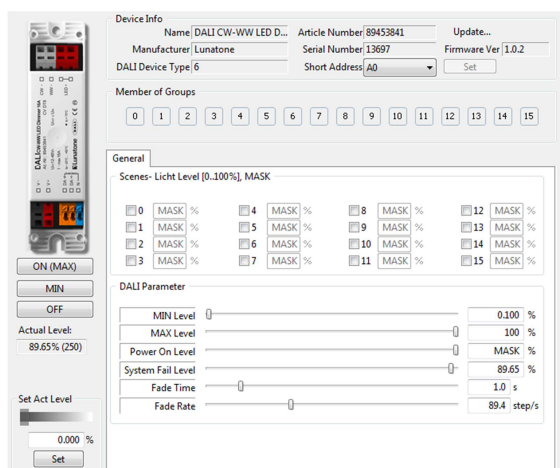

For each address the group membership can be set as well as scene values and DALI-parameters. In Balance&Dim operating mode all values assigned to channel 2 are representing the balance.

Factory Default Settings

Before the initial addressing is performed, the device can already be controlled by a group address. This predefined grouping will be deleted during the first addressing procedure. Afterwards groups can be assigned as usual (e.g. with the help of the DALI Cockpit). By sending a DALI-Reset command the device is set to the DALI default values as defined in the standard.

Summary of the factory default settings (delivery state):

operating mode	DT8																																																																																																
SwitchDim2	SwD1: level SwD2: colour temperature																																																																																																
Min Level	0.1%																																																																																																
PowerOn Level	MASK (last value)																																																																																																
Fade Time	2 (1s)																																																																																																
Fade Rate	5 (89.4 steps/s)																																																																																																
Tc-Stepsize	3 increments																																																																																																
PWM-frequency	122Hz																																																																																																
Groups before initial addressing:	G0 (or G0 and G1 in operating mode Balance&Dim)																																																																																																
Predefined Scene Values:	<table border="1"> <tr><td><input checked="" type="checkbox"/></td><td>0</td><td>MASK</td><td>%</td><td>6535</td><td>°K</td><td><input checked="" type="checkbox"/></td><td>8</td><td>MASK</td><td>%</td><td>4016</td><td>°K</td></tr> <tr><td><input checked="" type="checkbox"/></td><td>1</td><td>MASK</td><td>%</td><td>6060</td><td>°K</td><td><input checked="" type="checkbox"/></td><td>9</td><td>MASK</td><td>%</td><td>3831</td><td>°K</td></tr> <tr><td><input checked="" type="checkbox"/></td><td>2</td><td>MASK</td><td>%</td><td>5649</td><td>°K</td><td><input checked="" type="checkbox"/></td><td>10</td><td>MASK</td><td>%</td><td>3663</td><td>°K</td></tr> <tr><td><input checked="" type="checkbox"/></td><td>3</td><td>MASK</td><td>%</td><td>5291</td><td>°K</td><td><input checked="" type="checkbox"/></td><td>11</td><td>MASK</td><td>%</td><td>3508</td><td>°K</td></tr> <tr><td><input checked="" type="checkbox"/></td><td>4</td><td>MASK</td><td>%</td><td>4975</td><td>°K</td><td><input checked="" type="checkbox"/></td><td>12</td><td>MASK</td><td>%</td><td>3367</td><td>°K</td></tr> <tr><td><input checked="" type="checkbox"/></td><td>5</td><td>MASK</td><td>%</td><td>4694</td><td>°K</td><td><input checked="" type="checkbox"/></td><td>13</td><td>MASK</td><td>%</td><td>3236</td><td>°K</td></tr> <tr><td><input checked="" type="checkbox"/></td><td>6</td><td>MASK</td><td>%</td><td>4444</td><td>°K</td><td><input checked="" type="checkbox"/></td><td>14</td><td>MASK</td><td>%</td><td>3115</td><td>°K</td></tr> <tr><td><input checked="" type="checkbox"/></td><td>7</td><td>MASK</td><td>%</td><td>4219</td><td>°K</td><td><input checked="" type="checkbox"/></td><td>15</td><td>MASK</td><td>%</td><td>3003</td><td>°K</td></tr> </table>	<input checked="" type="checkbox"/>	0	MASK	%	6535	°K	<input checked="" type="checkbox"/>	8	MASK	%	4016	°K	<input checked="" type="checkbox"/>	1	MASK	%	6060	°K	<input checked="" type="checkbox"/>	9	MASK	%	3831	°K	<input checked="" type="checkbox"/>	2	MASK	%	5649	°K	<input checked="" type="checkbox"/>	10	MASK	%	3663	°K	<input checked="" type="checkbox"/>	3	MASK	%	5291	°K	<input checked="" type="checkbox"/>	11	MASK	%	3508	°K	<input checked="" type="checkbox"/>	4	MASK	%	4975	°K	<input checked="" type="checkbox"/>	12	MASK	%	3367	°K	<input checked="" type="checkbox"/>	5	MASK	%	4694	°K	<input checked="" type="checkbox"/>	13	MASK	%	3236	°K	<input checked="" type="checkbox"/>	6	MASK	%	4444	°K	<input checked="" type="checkbox"/>	14	MASK	%	3115	°K	<input checked="" type="checkbox"/>	7	MASK	%	4219	°K	<input checked="" type="checkbox"/>	15	MASK	%	3003	°K
<input checked="" type="checkbox"/>	0	MASK	%	6535	°K	<input checked="" type="checkbox"/>	8	MASK	%	4016	°K																																																																																						
<input checked="" type="checkbox"/>	1	MASK	%	6060	°K	<input checked="" type="checkbox"/>	9	MASK	%	3831	°K																																																																																						
<input checked="" type="checkbox"/>	2	MASK	%	5649	°K	<input checked="" type="checkbox"/>	10	MASK	%	3663	°K																																																																																						
<input checked="" type="checkbox"/>	3	MASK	%	5291	°K	<input checked="" type="checkbox"/>	11	MASK	%	3508	°K																																																																																						
<input checked="" type="checkbox"/>	4	MASK	%	4975	°K	<input checked="" type="checkbox"/>	12	MASK	%	3367	°K																																																																																						
<input checked="" type="checkbox"/>	5	MASK	%	4694	°K	<input checked="" type="checkbox"/>	13	MASK	%	3236	°K																																																																																						
<input checked="" type="checkbox"/>	6	MASK	%	4444	°K	<input checked="" type="checkbox"/>	14	MASK	%	3115	°K																																																																																						
<input checked="" type="checkbox"/>	7	MASK	%	4219	°K	<input checked="" type="checkbox"/>	15	MASK	%	3003	°K																																																																																						

Purchase Order Information

Art.Nr. 89453836: DALI CW-WW LED Dimmer, CV, input current 4A, 12V-28V DC, back box

Art.Nr. 86458673: DALI CW-WW LED Dimmer, CV, input current 8A, 12V-48V DC, SwitchDim2, back box

Art.Nr. 89453838: DALI CW-WW LED Dimmer, CV, input current 10A, 12V-48V DC, SwitchDim2, remote ceiling & integration in luminaires

Art.Nr. 89453841: DALI CW-WW LED Dimmer, CV, input current 16A, 12V-48V DC, SwitchDim2, remote ceiling & integration in luminaires

Additional Information and Equipment

DALI-Cockpit – free configuration tool from Lunatone for DALI systems

<http://lunatone.at/en/downloads/Lunatone-DALI-Cockpit.zip>

Lunatone DALI products

<http://www.lunatone.at/en/>

Lunatone datasheets and manuals

<http://lunatone.at/en/downloads/>

Contact

Technical Support: support@lunatone.com

Requests: sales@lunatone.com

www.lunatone.com



Disclaimer

Subject to change. Information provided without guarantee.
The datasheet refers to the current delivery.

The compatibility with other devices must be tested in advance to the installation.